



Greenhouse No 9

3 x 4.95 m / 14.85 m²

Thermowood (Thermo-pine)

Thermowood is a wood material produced by using natural methods, heat and steam. Thermal modification improves the wood's technical properties and Thermowood is non-toxic, dimensionally stable, resistant to decay and resin free. It can be used in any climate.

Thermowood properties:

- **Dimensional stability**
- **Reduced moisture content**
- **Improved durability against decay**
- **Reduced thermal conductivity**
- **Resin removed**
- **Consistent colour through the wood**
- **Non toxic material**

Thermowood of our choice is thermo treated pine. All constructions are made of very durable and robust 92 x 42 mm material.

Glass

All elements are glazed in 4 mm Tempered Safety Glass to European Standard EN 12150.

Fixings

Fixings are a combination of stainless steel and zinc coated steel, both being suitable for use with Thermowood due to their resistance to corrosion and extreme weather conditions.

Extras included

Bayliss triple spring automated roof window openers and door lock.

Warranty

Warranty for wooden construction is 10 years and 2 years for extras.



Dimensions

Width (A) – 3000 mm
Length (B) – 4950 mm
Eaves height (C) – 1700 mm
Ridge height (D) – 2900 mm
Door width (E) – 1400 mm
Door height (F) – 2100 mm
Wooden plinth height – 660 mm

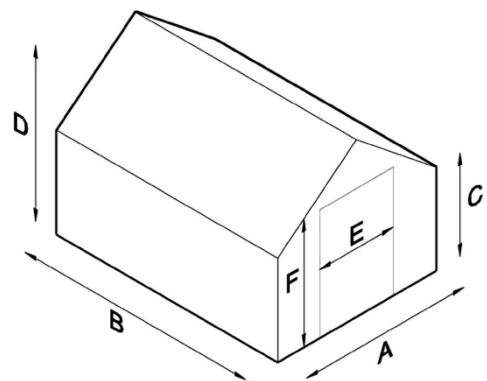

Roof pitch – 36°
Snow load – 250 kg/m²
Sidewind load – 45 kg/m²