



Greenhouse SG 2 foundation



Even the strongest greenhouse frame can only perform at its best when it stands on a stable and properly prepared base. A properly built foundation keeps the greenhouse level, prevents twisting or movement and ensures that all doors, vents and panels align and operate smoothly. It also provides protection against moisture, ground frost and strong winds that could otherwise damage the frame over time.

To accommodate different garden designs and installation needs, our greenhouses can be placed on various suitable surfaces, including stone paving or a strong wooden terrace. These options can work well when carefully leveled and reinforced. However, for the highest stability, best durability and longest service life, we strongly recommend a concrete/stone foundation. Either a solid concrete slab or a concrete/stone strip foundation offers exceptional support and keeps the greenhouse secure in all weather conditions.

Taking the time to plan and build a proper foundation will make assembly easier and will protect your investment for years to come. When the base is right, the entire greenhouse benefits — because everything starts from a good foundation.



1. Concrete slab foundation

1.1. Foundation plan

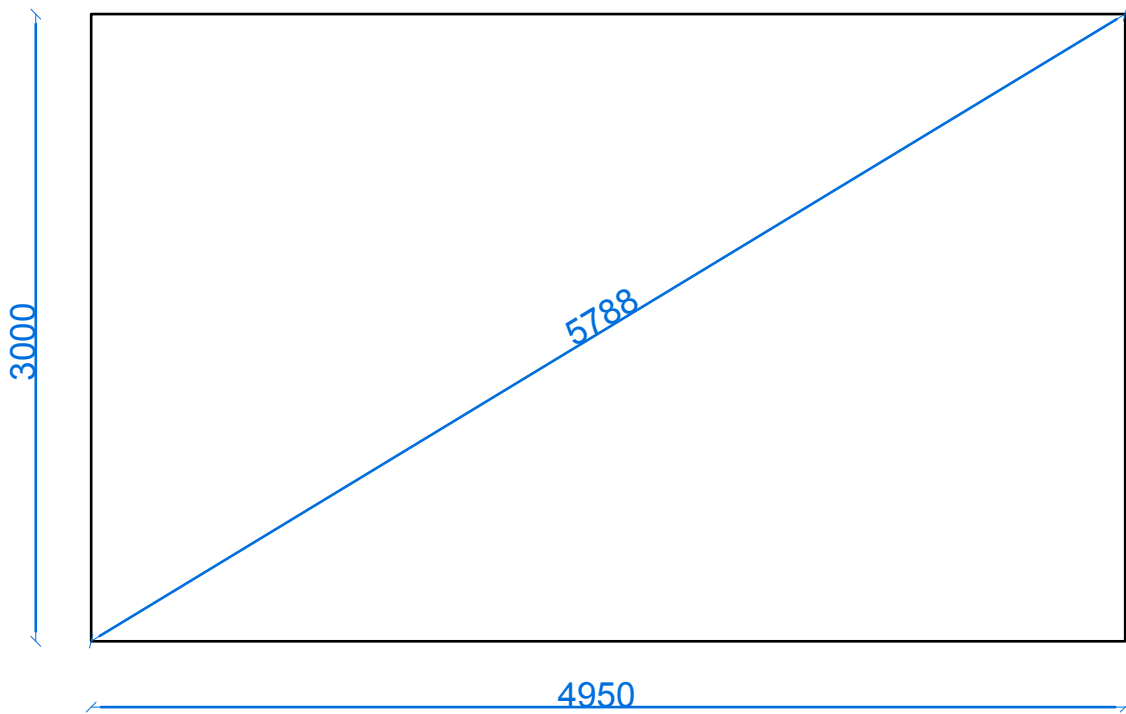

Foundation plan M 1:50

* All measures are in mm



1.2. Foundation section

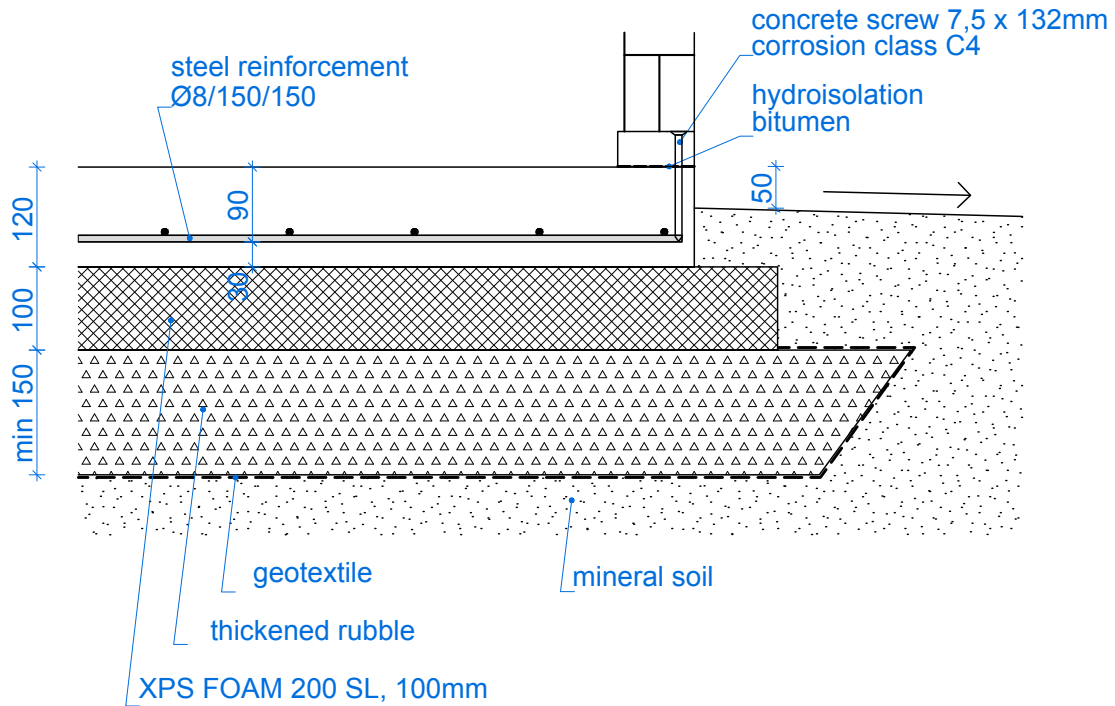

Foundation section M 1:10

Notes:

1. Foundation concrete plate type C25/30, environmental class XC2.
2. Reinforcing bars are weldable rib bars, yield strength $f_{yk}=400\dots600$ MPa.
3. Thickened rubble thickness factor 0,95.

* All measures are in mm



2. Strip foundation

2.1. Foundation plan

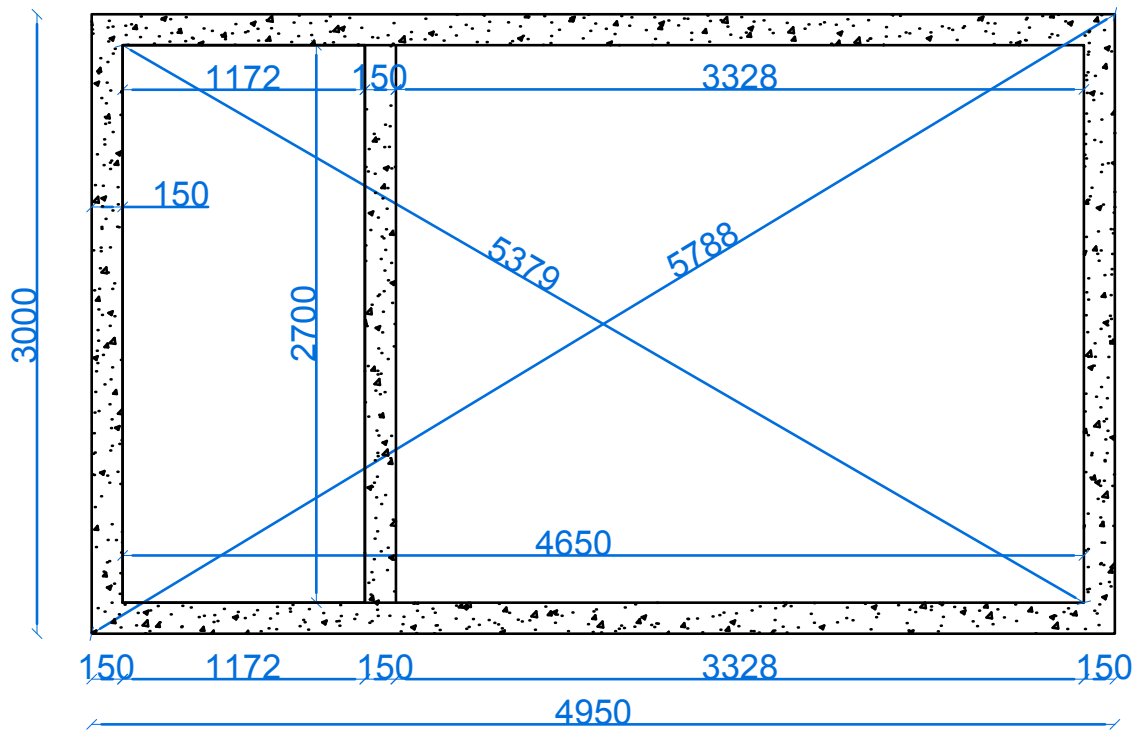

Foundation plan M 1:50

* All measures are in mm

2.2. Foundation section

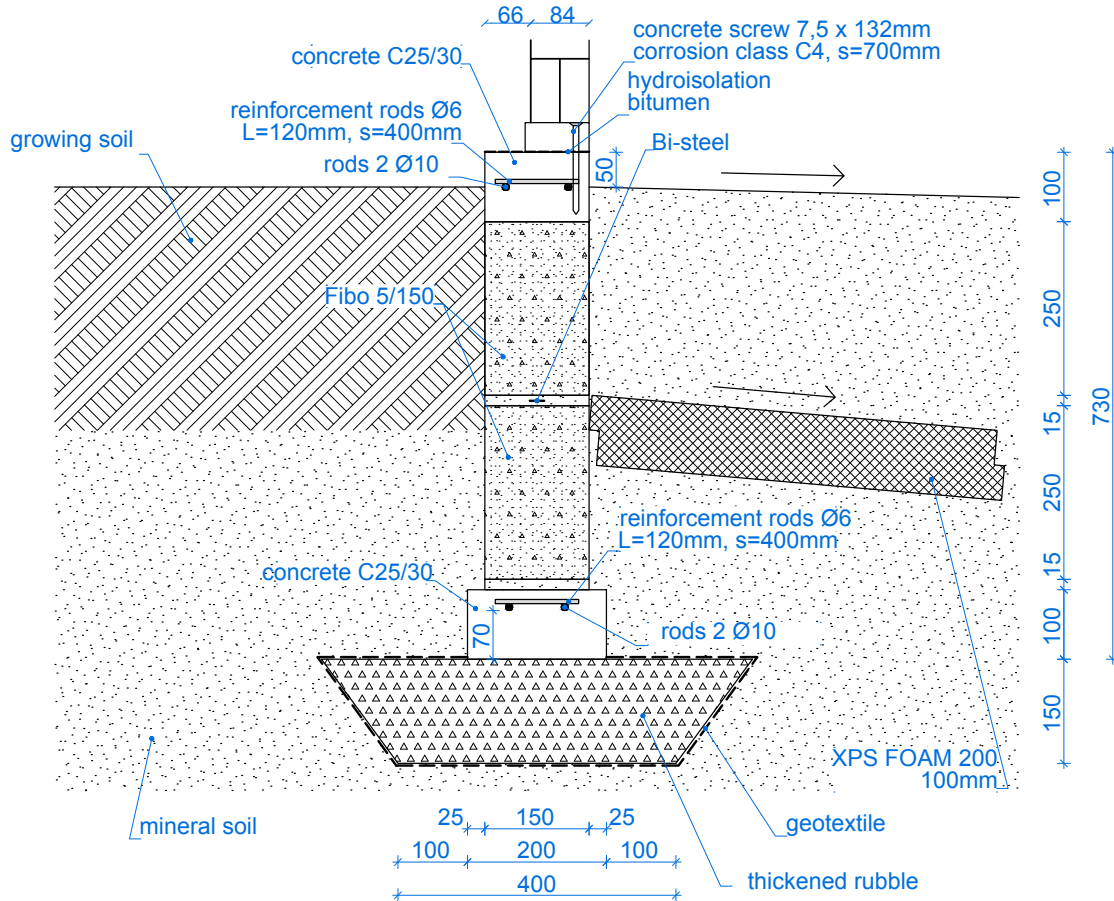

Notes:

1. Foundation concrete plate type C25/30, environmental class XC2.
2. Reinforcing rods are weldable rib rods, yield strength $f_{yk}=400\text{...}600$ MPa.
3. Thickened rubble thickness factor 0,95.
4. Lay blocks with full horizontal and vertical joints, mortar paste compression strength min 20 MPa.
5. Bi-steel fully inside brick mortar.
6. When laying blocks, use a wall mixture with normal compressive strength 8MPa.
7. In case of high groundwater, build the foundation with the drainage system.

Foundation section M 1:10

* All measures are in mm